



DANACHRIS
GENERAL TRADING LLC

PROCUREMENT AND INNOVATIVE ENGINEERING





About Our Company



A Brief About The Company

Danachris General Trading LLC was established in 2008 in Dubai, United Arab Emirates with the purpose of providing high quality goods and products that will serve Europe, Middle East, Asia, and African (EMEA) markets. We are a procurement and innovative engineering company with various divisions. In Danachris, procurement and sourcing is one of our core capabilities; we are strong and courageous in providing client's specifications and turnkey solutions; that covers, industrial and domestic supplies. As an innovative engineering company, we are solution driven; we solve client problems by applying the principles and process of engineering design to innovatively arrive at the most sustainable and cost-effective solution.



Industries We Serve



OIL & GAS
AND MARINE



AGRICULTURE



AUTOMOBILE



CHEMICAL AND
MANUFACTURING PLANTS



FOOD AND WATER
INDUSTRIES



CONSTRUCTION AND
MINING



DANACHRIS SUPPLIES



In Danachris,
strategic sourcing and procurement
is within our core capabilities;
we are strong and courageous in providing
client's specifications from OEM and turnkey solutions.
We are also stockists of several items.

- ✓ Competitive pricing
- ✓ Good lead time
- ✓ Transparency
- ✓ Industry compliance

INNOVATIVE ENGINEERING



In Danachris,
as a solution driven company,
we solve client problems by applying the principles and process of
engineering design to innovatively arrive at the most
sustainable and cost-effective solution.

- ✓ DESIGN & FABRICATION
- ✓ ENGINEERING CONSULTING SERVICES
- ✓ INSTALLATION, MAINTENANCE, AND REPAIR SERVICES

LINE CARD



LUBRICANT AND GREASE

Castrol, Mobil, Shell, Caltex, Valvoline, LUKOIL

CHEMICAL INJECTION QUILLS

see description page

ANALYTICAL & MEASUREMENT INSTRUMENT

Antek by PAC: for oil and gas companies

TRUCKS AND HEAVY EQUIPMENT & SPARE PARTS

SCANIA, Westlake, ITR, CAT, KOMATSU see more on description page...

PIPES, VALVES, & FITTINGS

Starline ball valves, Goodwin Valves, Schlesinger,

ENERGY STORAGE SOLUTIONS

Saft, Alcad, Power Sonic, and AC Delco Batteries

PERSONAL PROTECTIVE EQUIPMENTS (PPE)

Ansell, Honeywell, 3M

INDUSTRIAL FILTRATION SOLUTION

Dollinger, RO filtration solutions

INSULATION, CLADDING, SCAFFOLDING ITEMS

Rockwool, Aluminum strappings, ceramic fibre blanket, foamglas, calcium silicate, perlite insulation

OIL FIELD DRILLING & MINING TOOLS & SUPPLIES

NUMA, Southwest, and more

WORKSHOP TOOLS AND CONSUMABLES

Greenlee, RIDGID, HILTI, ESAB

Contact us for more details

ALCAD **Shell** **LUBCON** **Mobil**
DUMORE **Castrol**
DELLON **SUPER**
POWERPS SONIC TRUSTED BATTERY SOLUTIONS
RITTAL **CAT**
EnerSys. **ABB**
KRAL **WIX** FILTERS
SERO PumpSystems **Donaldson** FILTRATION SOLUTIONS
PENNBARRY **BAUER**
saft **Raychem**
Atlas Copco **BaumerHübner**
ALLEGRO INDUSTRIES **KOMATSU**
Cleanova **IR** Ingersoll Rand
ALLWEILER **marathon** electric
FUCHS **ebmpapst**
SCANIA **Sauer Compressors**
KLÜBER LUBRICATION

DANACHRIS
GENERAL TRADING LLC
YOUR TRUSTED INDUSTRIAL SPARES AND LUBRICANTS SUPPLIER
EXCELLENCE IN
PROCUREMENT & SOURCING

SOME BRAND LIST



1. BOSCH REXROTH
2. ABB
3. SIEMENS
4. JUMO
5. WIKA
6. SCHNEIDER
7. BAUER GEAR MOTOR
8. ENDRESS+HAUSER
9. SAFT BATTERY
10. AMETEK
11. JUMO
12. DURAG
13. NORGREN
14. PR ELECTRONICS
15. EBM PAPST
16. RITTAL
17. SYSTEM SENSOR
18. SAGINOMIYA
19. FLIR
20. RAYCHEM
21. ALCAD BATTERY
22. POWER SONIC BATTERY
23. AC DELCO BATTERY
24. CASTROL
25. FUCHS
26. SHELL
27. TR ELECTRONIC
28. BAUMER, ENCODER
29. DOLLINGER FILTERATION
30. KLUBER
31. MOBIL
32. DELLON
32. INGERSOLL RAND, PARTS FOR AIR COMPRESSOR
33. PHEONIX CONTACT
34. FLEETGUARD
35. FLUKE, SPARES
36. ROHDE & SCHWARZ, SPECTRUM ANALYZER
37. SAUTER, SPARES
38. MITSUBISHI, COMPRESSOR
39. GUTOR BY SCHNEIDER
40. MARATHON ELECTRIC MOTOR
AND MORE...



Trust meets trade

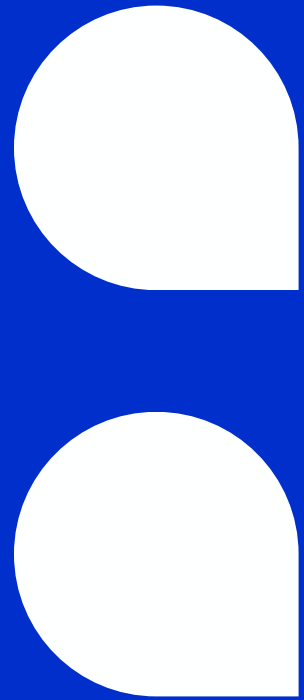

INDUSTRIAL LUBRICANTS



INDUSTRIAL SUPPLIES

Industrial Lubricants

- Danachris is a stockist and supplier of Industrial oils:
 - Compressor oils, Gear oil, Hydraulic oils, Fire resistant hydraulic, slide way lubricants; circulating oils, Spindle oils, Food grade oils, biodegradable oils
 - Turbine oil, Concrete mold oils, rock drill oils, steam reciprocating oils, heat transfer oils, refrigeration oils, process oils, transformer oils
 - Gas engine oils, rotary screw compressor oils, bearing and circulating oils
 - Marine lubricants
- Danachris is a stockist and supplier of Industrial greases:
 - Temperature dependent greases
 - Multi-purpose high performance
 - Valve grease: gate valve lubricant, high & low temperature greases, synthetic gate and plug valve lubricant.



CASTROL, MOBIL, SHELL, CALTEX
MOLYKOTE, KLUBER, VALVOLINE, LUKOIL





Trust meets trade

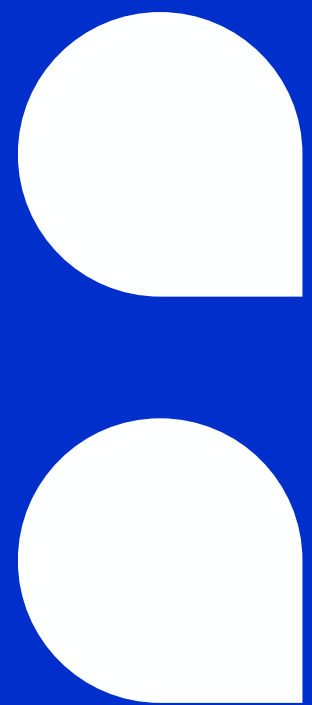

ENERGY STORAGE SOLUTIONS AND SYSTEMS



ENERGY STORAGE SOLUTIONS



Powering the Future

Danachris is a supplier of Energy Storage Solutions, specializing in providing reliable and efficient power solutions, including UPS systems, for diverse industrial applications. Notable brands we supply include: Alcad, Saft, Power Sonic, AC Delco etc.



POWER *PS* SONIC
TRUSTED BATTERY SOLUTIONS

ALCAD **saft**

ACDelco

RELIABLE ENERGY STORAGE FOR DEMANDING INDUSTRIES



- **Ni-Cd Batteries:**
 - Proven performance, durability, reliability
 - Ideal for UPS systems, emergency backup, and harsh environments.
- **Li-ion Batteries:**
 - High energy density, lightweight, fast charging
 - Ideal for EVs, grid storage, and renewable energy integration
- **Our Expertise:**
 - Competitive pricing support, Customized solutions, expert design & installation, comprehensive service & support.
- **Why Choose Us:** Partnerships with leading manufacturers, focus on client satisfaction.





Trust meets trade

INSULATION, CLADDING, SCAFFOLDING ITEMS



INDUSTRIAL SUPPLIES

Insulation Solutions

Danachris supplies high quality insulation and cladding items and accessories required during construction phase of your project.

- Rockwool Insulation (Saudi and Fujairah)
- Foamglas
- Perlite insulation materials
- Aluminum coil & strapping for insulation
- Acoustic Rock Wool Insulation Board
- Ceramic Fiber Blanket and more....

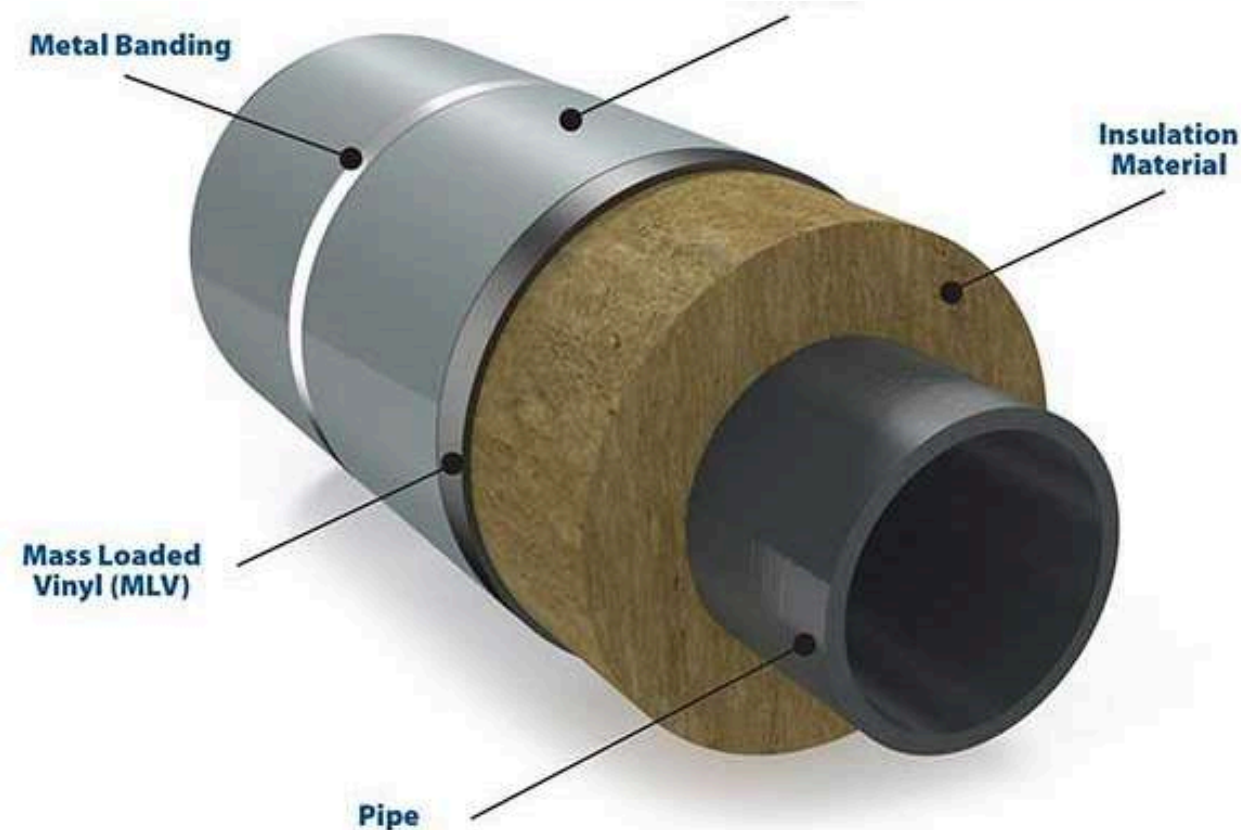
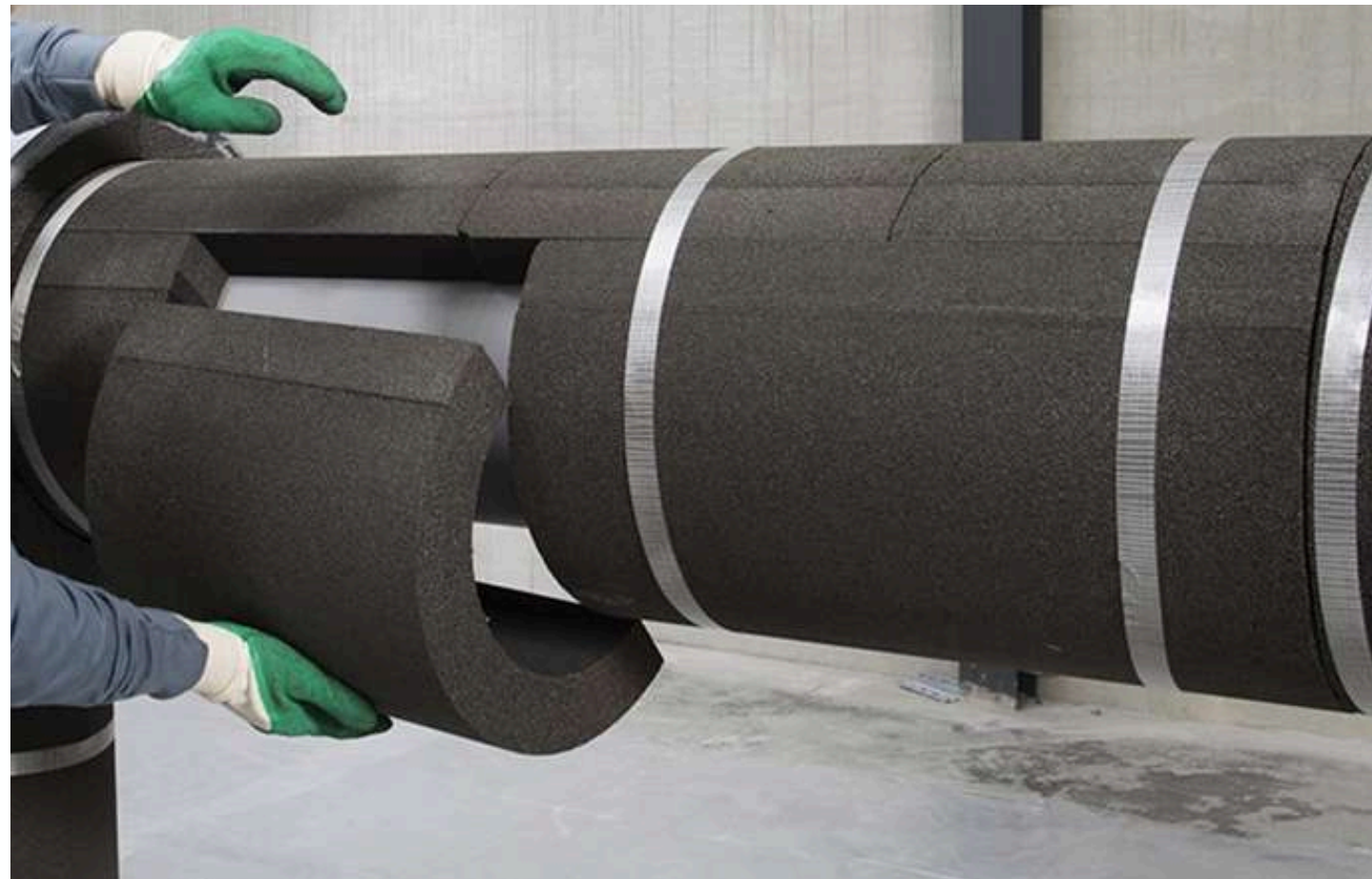



Trust meets trade

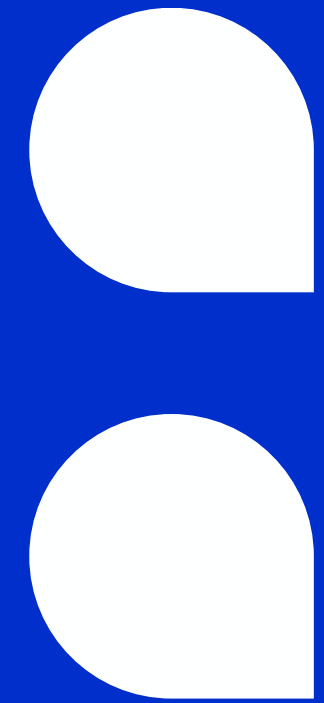

INDUSTRIAL BORESCOPE, VIDEOSCOPE, AND NDT TOOLS



INDUSTRIAL SUPPLIES



Safety PPE, Workshop Tools and Consumables

Danachris is a leading provider of advanced inspection solutions for industries across various sectors.

As an authorized distributor of Dellon, we offer a comprehensive range of high-quality borescopes, videoscopes, and NDT tools."

Partner with Danachris for reliable and innovative inspection solutions powered by Dellon technology.





Trust meets trade

PIPES, FITTINGS & VALVES



INDUSTRIAL SUPPLIES

Pipes, valves, and fittings

Danachris provides client's specifications and turnkey solutions and equipment required for your projects. These include:

- SS grade Pipes
- CS and MS pipes and fittings
- CS, SS fittings (valves, flanges, bolts & nuts, gaskets)
- Metals and tubes pipes
- SS Seamless tubes, Heat exchanger tubes, boiler tubes & pipes, instrumentation tubes
- seamless pipes, heater pipes, hollow bars, welded tubes, welded pipes, titanium welded tubes, longitudinal pipes
- External and internal coated CS pipes, HF-ERW pipes, SAW pipes
- PTFE lined pipes and fittings
- Corrosion resistant pipes and fittings
- Valves: dual check, butterfly, plug, piston, gate, ball etc.
- SS Sheets and plates

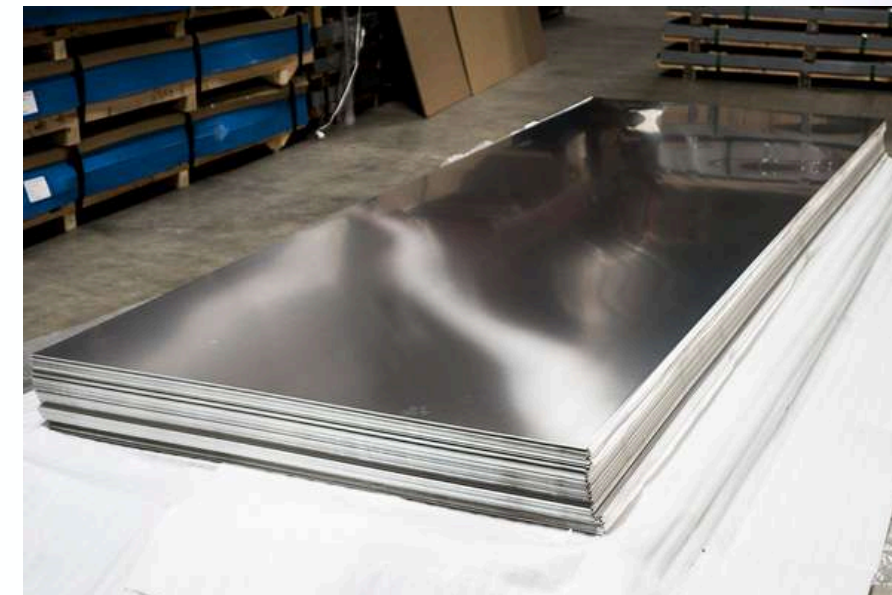



Trust meets trade

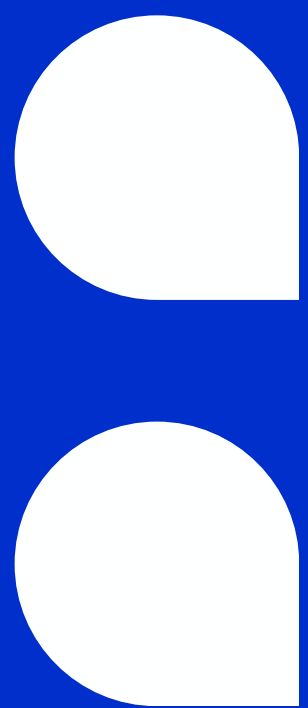

CHEMICAL INJECTION QUILLS

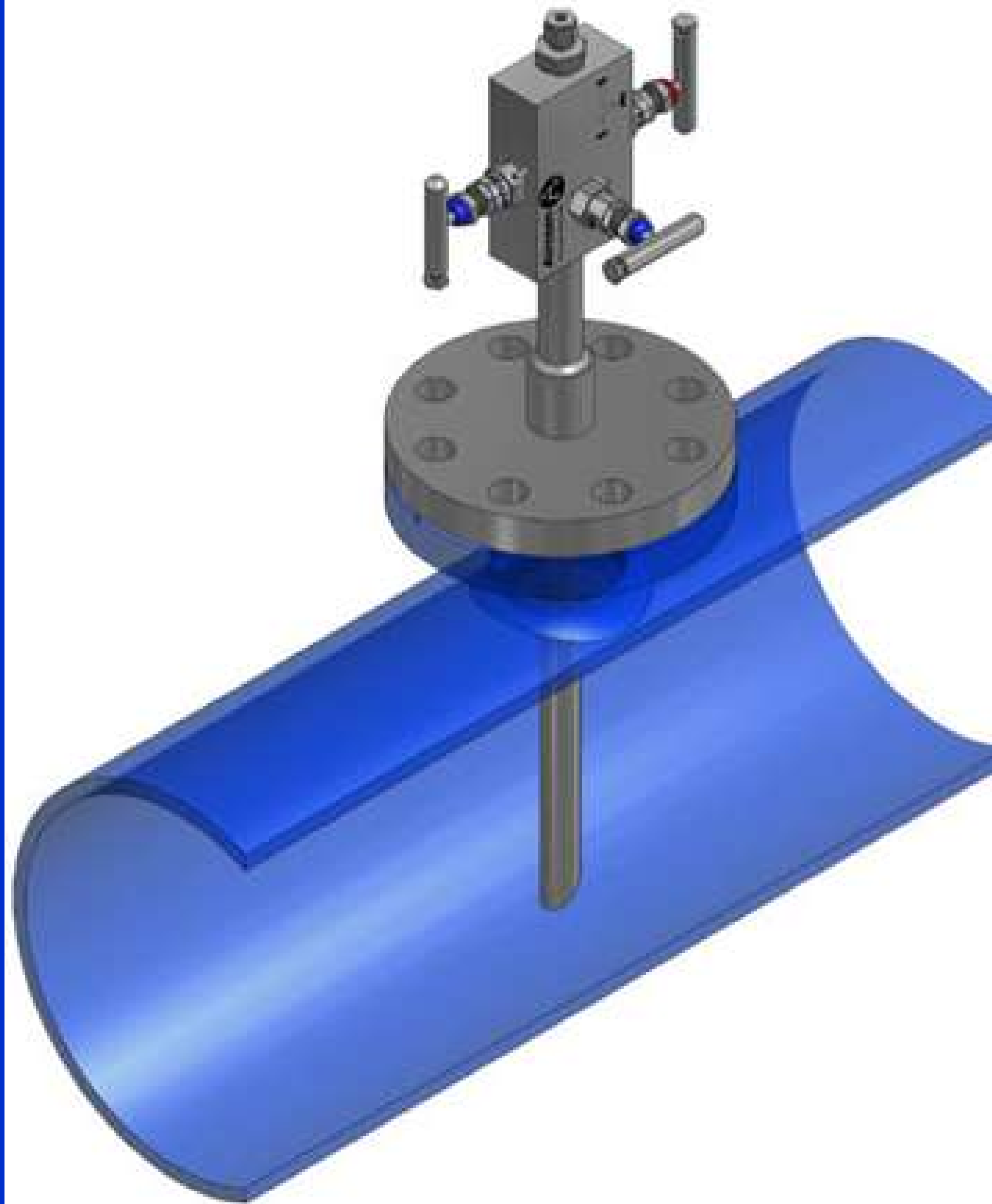



INDUSTRIAL SUPPLIES

Chemical injection quills and sampling probes

We supply cost effective chemical injection quills used for dosing or introduction of corrosive chemicals in manner that is safe, controlled, and accurate. The types we support include but is not limited to the following:

- Injection quills with DBB valve
- Online retrievable chemical injection quill assembly
- Retrievable tool and service valve
- Retractable injection quill with safety clamp
- Retractable injection quill with safety chain
- Fixed type chemical injection quill

All manufactured and tested according to the required quality standards.

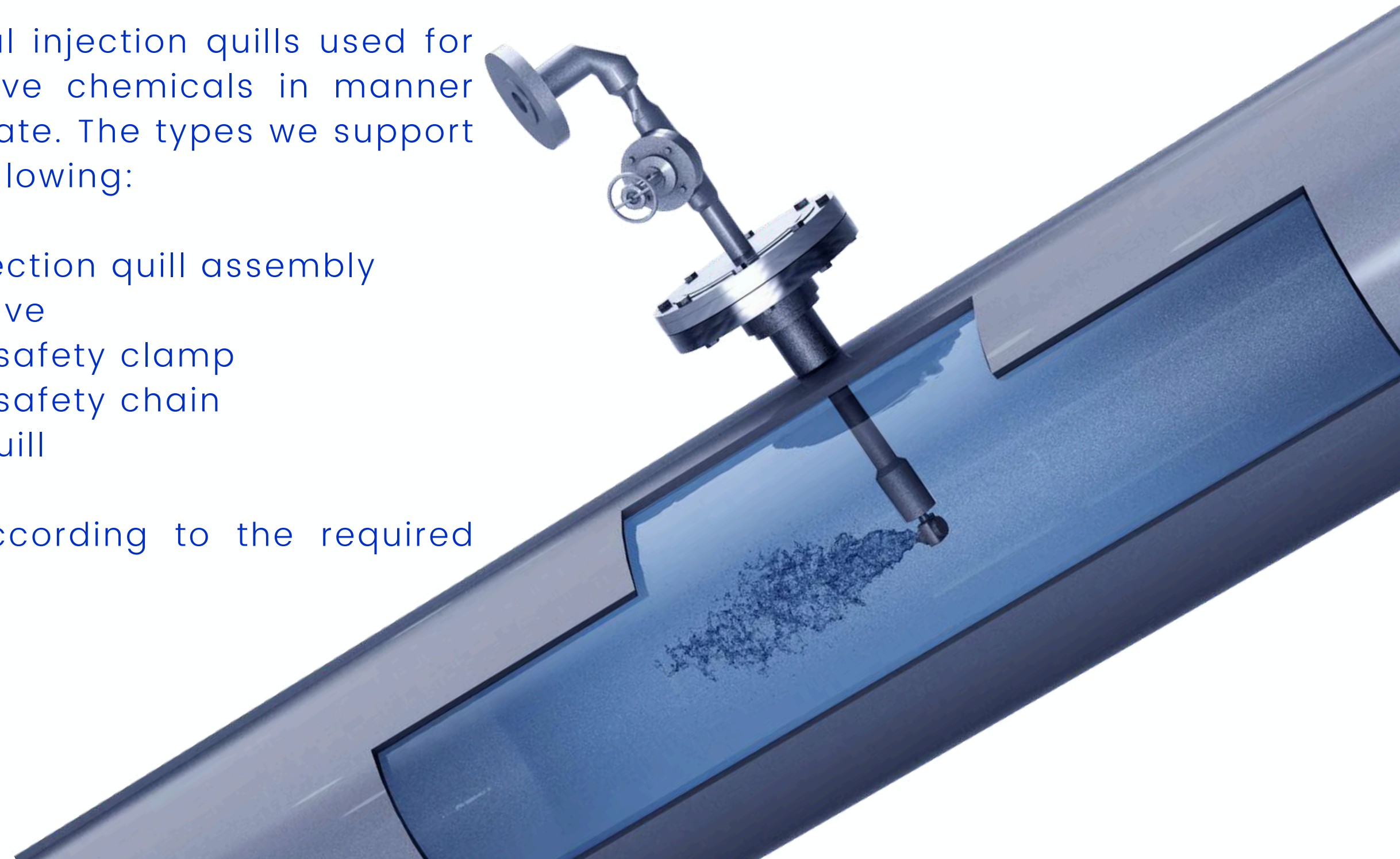



Trust meets trade

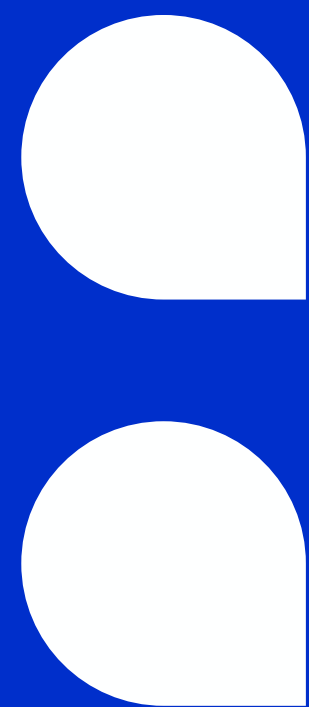

ANALYTIC, MONITORING & MEASUREMENT INSTRUMENTS

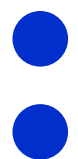

INDUSTRIAL SUPPLIES

Analytic, Monitoring & Measurement Instrument

Danachris supplies the latest technological solutions for monitoring, measuring, and analyzing required parameters in oil and gas, wastewater, food and beverage, refinery marine, and petrochemical facilities.

These solutions are innovative in their fields for gas, LPG, and liquid sample analysis; some of which can be done in real-time.

The applications include but is not limited to:

- Total Sulfur and Total Nitrogen Analysis
- Oil analysis
- Water in oil
- Coatings, Paint, and Ink
- Fuel analysis
- Gas analysis





Trust meets trade

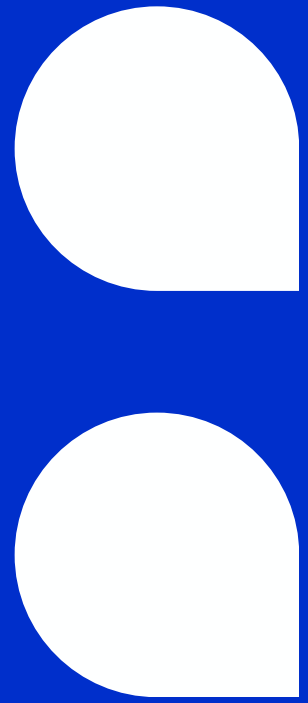

FILTRATION SOLUTIONS



INDUSTRIAL SUPPLIES

Filtration Products and Systems

Danachris provides filtration products used for various filtration and pre-filtration processes of the oil and gas, chemical, and water industries.

The products supplied include filter cartridges, filter housings, filtration technology and systems. The industries we focus on in this segment include the following:

- Oil & Gas
- Refinery & Petrochemical
- Chemical
- Power Generation
- Sewage and Wastewater treatment





Trust meets trade

OIL FIELD DRILLING & MINING TOOLS & SUPPLIES

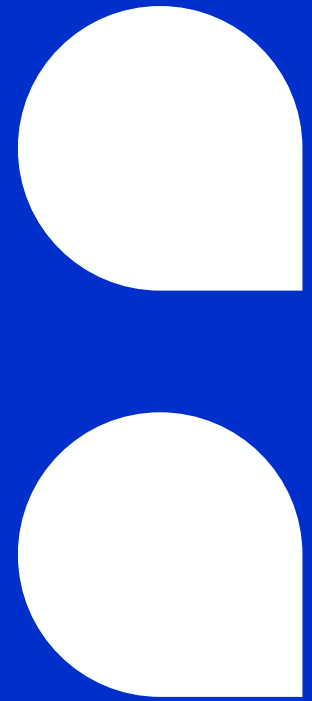

INDUSTRIAL SUPPLIES

Oil Field Drilling & Mining Tools

From drilling tools and casing centralizers to wellhead spools, we have everything you need to ensure the success of your project. Our range of products includes:

- Casing Centralizer
- Cementing Head
- Cementing Plug
- Float Collar / Float Shoe / Reamer Shoe
- Stage Tools
- Liner Hanger
- Casing Packer
- Wellhead Spool (Casing Head, Tubing Head)
- DSA (Double Studed Adapter)
- Spacer Spool
- Sucker Rod Pump
- Drill Pipe, Drill Collar & Stabilizers
- Pumping Unit
- BOP

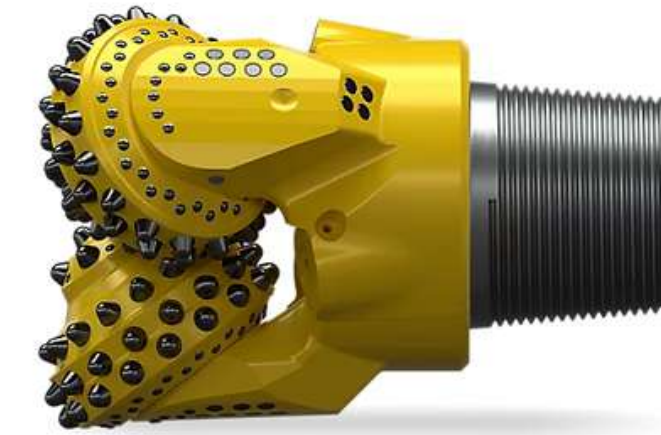
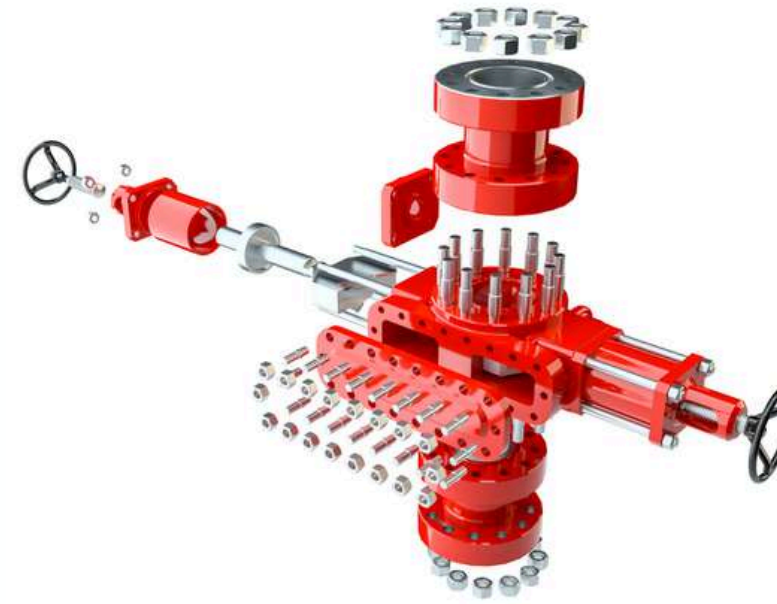

At Danachris, we are committed to providing you with the highest quality products and services.

That's why we supply only API & ISO certified products to ensure that our products meet the strictest standards.



Trust meets trade

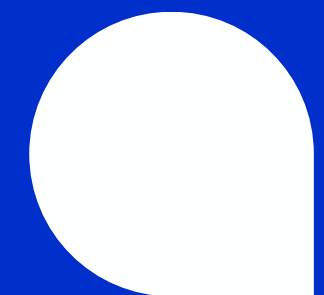

INDUSTRIAL WORKSHOP

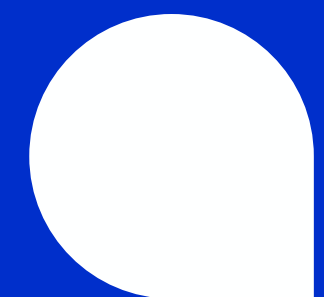

PPE & WORKSHOP TOOLS

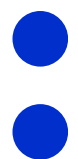



INDUSTRIAL SUPPLIES

Safety PPE, Workshop Tools and Consumables

Danachris supplies high quality personal protective equipments.

- Body PPE
- Head Face and Eye PPE
- Respiratory PPE

Danachris supplies high quality workshop tools and consumables used in various industries including but not limited to oil and gas, marine, automobile sectors.

BRANDS





Trust meets trade

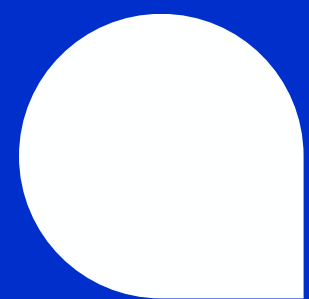
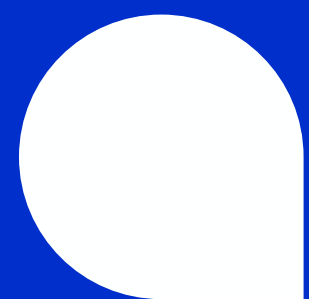

TRUCKS AND HEAVY EQUIPMENT PARTS

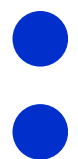

TRUCKS & HEAVY EQUIPMENT

Spare Parts and Equipment



This Danachris division supplies equipment and spare parts of heavy equipment and trucks. The range of items we focus on include the following:

- Truck spare parts
- Heavy Duty Tires





Trust meets trade

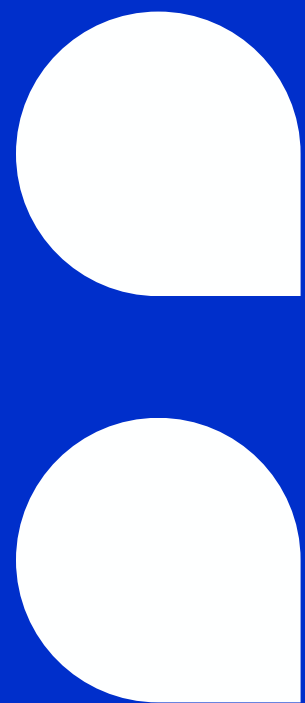

ELECTRIC VEHICLE CHARGERS

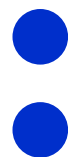

ELECTRIC VEHICLE CHARGER

This latest division of Danachris supplies EV chargers and accessories. Danachris is contributing to fulfilling the agreements made in the recent COP28 climate summit. The products we supply and install include but is not limited to the following:

- EV charging accessories and adaptors
- EV DC charges
- EV Wall box
- EV Charging Stations

Furthermore, we training and support programs to help existing garages develop and transition to supporting EV car repairs.



32A single phase

IP 65

CE

IK 10



Type 2



CAR DIAGNOSTIC & PROGRAMMING TOOLS

Light and Heavy Vehicles

As an extension of our vehicle spare parts division, Danachris is a stockist and supplier of:

- Car diagnostic scanners
- Car ECU programming tools
- Car key programming tools



THINKCAR

AUTEL[®]

AUTOMOTIVE INTELLIGENCE

TOPDON

LAUNCH





Trust meets trade

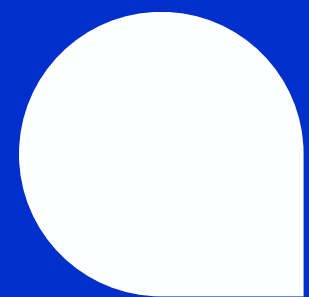
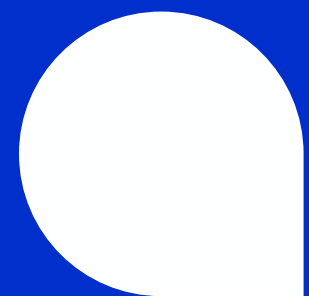

CLIENTS SERVED DIRECTLY & INDIRECTLY





CLIENTS SERVED DIRECTLY & INDIRECTLY



Chevron, Nigeria



ADNOC, UAE



Shell, Iraq



Saudi Chevron Phillips,
Kingdom of Saudi
Arabia



لحلول المرافق
FACILITIES SOLUTIONS



United Arab Emirates



BAYANA CONSTRUCTION LIMITED

Kenya



Imdaad

United Arab Emirates



Savannah Sugar
Company, Nigeria

Danachris is Dependable





Certificate Of Registration

Awarded to

DANACHRIS GENERAL TRADING LLC

at

P.O. BOX NO: 299764, NO. 03, AJG BUILDING, AL NAKHEEL ROAD, NAIF, DEIRA,
DUBAI, UAE

Quality Registrar Systems certify that the management system of the above organization has been audited and found to be in compliance with the QRS & ISO standard requirements for registration of the management system

standard detailed below:

ISO 9001:2015

Quality Management Systems

Scope of work

SUPPLY OF INDUSTRIAL PIPES & FITTINGS, INDUSTRIAL LUBRICANTS, INDUSTRIAL FILTERS, AUTO SPARE PARTS, VEHICLES DIAGNOSTIC & PROGRAMMING TOOLS, INSULATION & CLADDING ITEMS, WELDING MACHINERIES & CONSUMABLES, MOTOR ENGINE OIL, SPARE PARTS FOR TRUCKS & HEAVY EQUIPMENT

EA 29

Certificate No: ADU-2230

Originally Registered: 01 APR 2023

Latest Issue: 27 MAR 2026

Valid up-to: 31 MAR 2029

SURV. AUDIT ON OR BEFORE: 21 FEB 2027

RE-CERTIFICATION DUE ON: 27 MAR 2029

Quality Registrar Systems



QUALITY REGISTRAR SYSTEMS

P.O Box :26826
United Arab Emirates



Tel: +971-2-6714302
Tel: +971-2-3096166
www.qrsyst.com

WORLDWIDE CERTIFICATION

This certificate is the property of Quality Registrar Systems and remains valid subject to satisfactory annual surveillance audit.
This certificate is only valid when confirmed by the Register listed in Quality Registrar Systems (qrsyst.com)

CONTACT US



SCAN FOR GPS



No 3. AJG Building, Al Nakheel Street, Deira, Dubai, United Arab Emirates



+971 4 351 4489



+971 56 551 1320



@danachrisuae



@danachrisuae



Danachris General Trading LLC



info@danachrisuae.com



www.danachrisuae.com

Danachris - Dependable

